

LED HighBay



LED linear high bay provides high output illumination for various commercial and industrial applications, like factory, warehouse, exhibition hall, gymnasiums, retail boxstores.

Product Feature :

High lumen output, 135LPW.

AC100-277V and AC200-480V available.

5 year warranty.

Compatible with dimmers, Sensors and other control strategies, to achieve deeper energy-saving.

Technical parameters

Model	FY-HB-600D-95W	FY-HB-600D-125W	FY-HB-1200D-160W	FY-HB-1200D-225W	FY-HB-1200D-320W
Power	95W	125W	160W	225W	320W
Length	2FT	2FT	4 FT	4FT	4FT
Size	612*325*53	612*325*53	1220*325*53	1220*325*53	1220*325*53
Lumen	130-140lm/w				
PC cover	Clear, Frosted				
Driver	UL driver, dimmable available				
Input Voltage	AC100-277V , AC200-480V 50Hz/60Hz				
CCT	3000K-6500K				
CRI	80 Ra				
Warranty	5 Years				

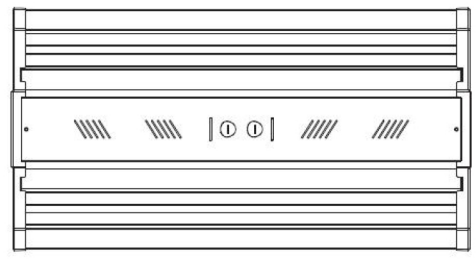
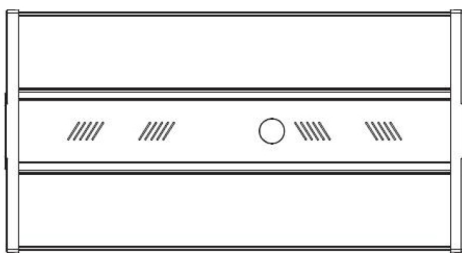

Product information

Different installation:

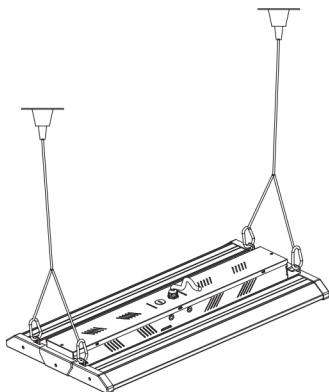

Suspended cable

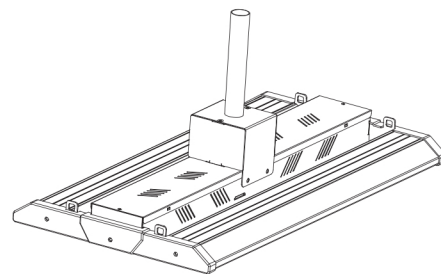

pendant mount

Function and options

1. Bi-Level control

The PIR sensor to achieve tri-level dimming control, for same areas that require a light change notice before switch off.

It offers 3 levels of the light Control : 100%--dimming light (0,10%,30%,50%)--off; and 2 periods of selectable waiting time: motion hold-time and stand-by time. Selectable daylight threshold and choice of detection area.

PIR sensor

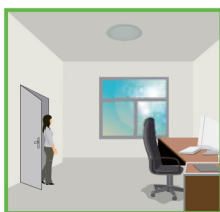
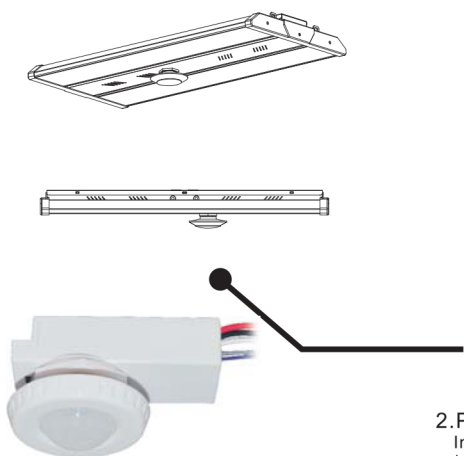

With sufficient natural light, the light does not switch on when presence detected.

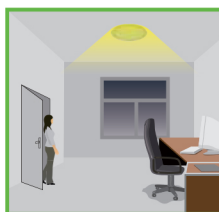

With insufficient natural light, the sensor switches on the light automatically when person enters room.

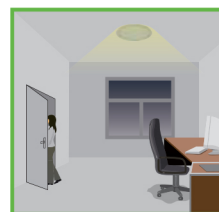

People left, light still dims to 0/10%/30%/50% (options) standby level after the hold time.



Light switches off automatically after after stand-by time elapsed.

2. Photocell(Daylight sensor) Control

In condition by setting, Press **Ⓜ**, the photocell(Daylight sensor) on/off setpoint is open. When the light level exceeds this setting, the lights will turn off even when the space is occupied. Once the light level exceeds this setting, the sensor will wait and monitor for 1 min in order to confirm the light level increase is not temporary before forcing the lights to go off. When light level goes below the settings, the light will turn on even without motion detection after 1 min. This feature is disabled by default.

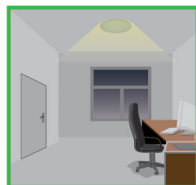

If with insufficient natural light, the light automatically dims to 0, 10%, 30%, 50%.

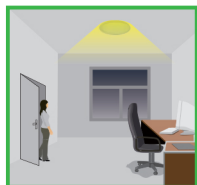

With insufficient natural light, the sensor switches 100% on the light automatically when person enters the room.

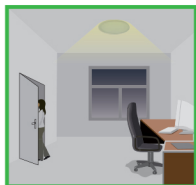

People left, light dims to 0/10%/30%/50% (options) standby level after the hold time.



The light still dims to 0/10%/30%/50% if still insufficient natural light, the light never switch off until sufficient natural light.



Light will switch off automatically even with presence detected, if the nature light is sufficient.

Coverage Patterns

L3

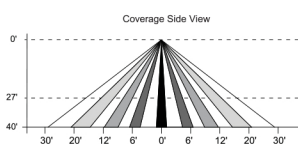

360° Coverage

Coverage Top View

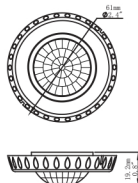
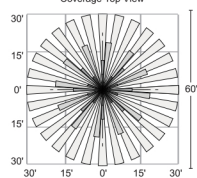

L4

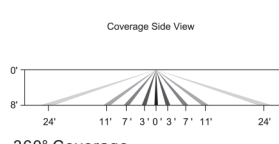

360° Coverage

